

SEC. NO. IS0001
WEIGHT - 0.320 Kg/M

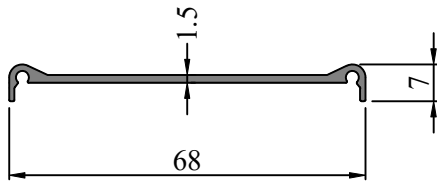

SEC. NO. IS0002
WEIGHT - 0.640 Kg/M

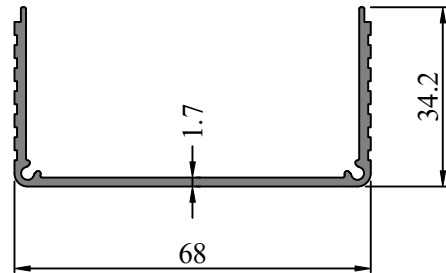

SEC. NO. IS0003
WEIGHT - 0.730 Kg/M

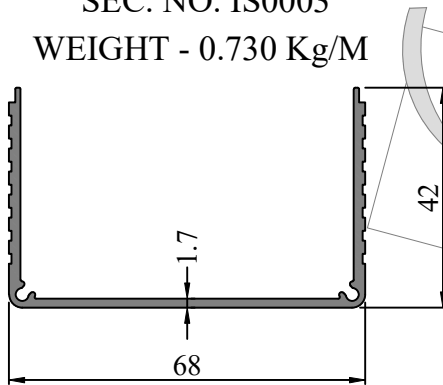

SEC.NO. IS0004
WEIGHT - 2.80 Kg/M

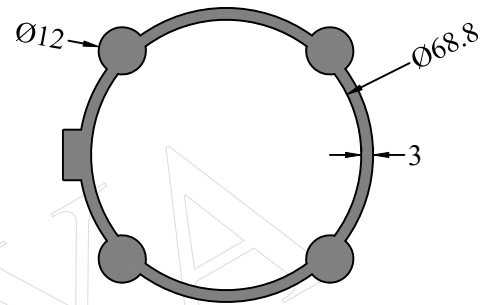

SEC.NO. IS0005
WEIGHT - 0.870 Kg/M

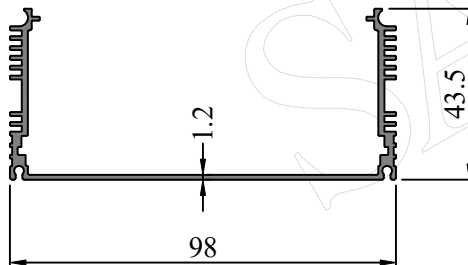

SEC.NO.IS0006
WEIGHT - 0.340 Kg/M

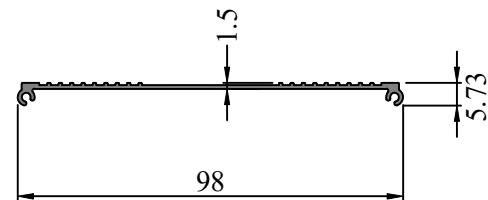

SEC. NO. IS0007
WEIGHT - 0.730 Kg/M

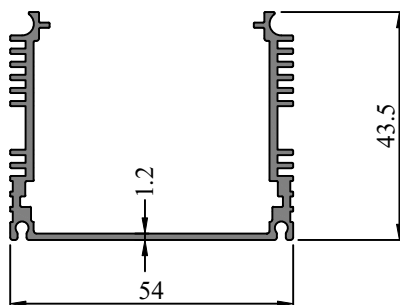

SEC. NO. IS0008
WEIGHT - 0.215 Kg/M

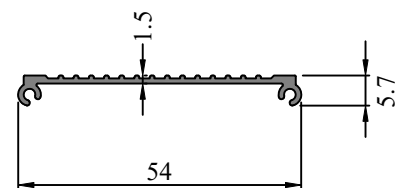

ALL DIMENSIONS ARE IN MM

WEIGHT TOLERANCE ± 7 TO 10%

REVISED ON DATE - 24/03/2026

SATYA METAL INDUSTRIES PVT.LTD

Address : Khasra No.480, Shimla Pistaar, Kichha Road Rudrapur, U.s.Nagar, Uttarakhand - 263153
 Mob: +91-8477897789 | +91-9415215083 | E-mail : satyametal@rediffmail.com | Website : www.satyametal.com

SEC. NO. IS0009
WEIGHT - 1.30 Kg/M

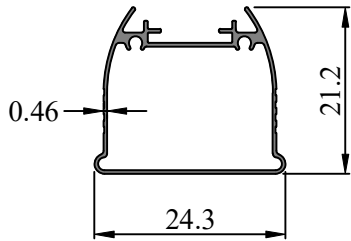

SEC.NO. IS0025
WEIGHT - 2.345 Kg/M

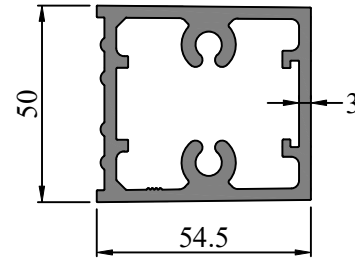

SEC. NO. IS0032
WEIGHT - 0.780 Kg/M

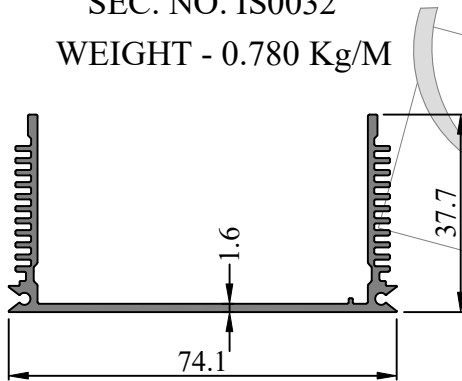

SEC. NO. IS0033
WEIGHT - 0.470 Kg/M

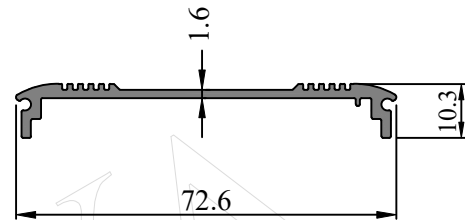

SEC. NO. IS0036R1
WEIGHT - 0.566 Kg/M

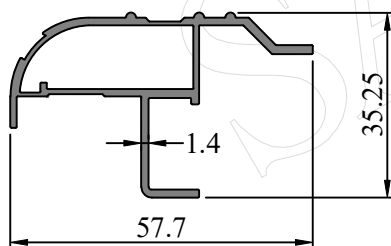

SEC. NO. IS0037
WEIGHT - 0.100 Kg/M

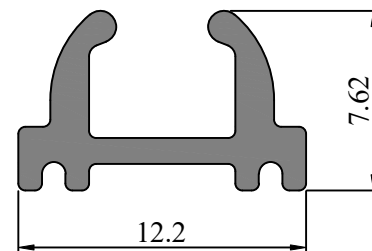

SEC. NO. IS0038
WEIGHT - 1.40 Kg/M

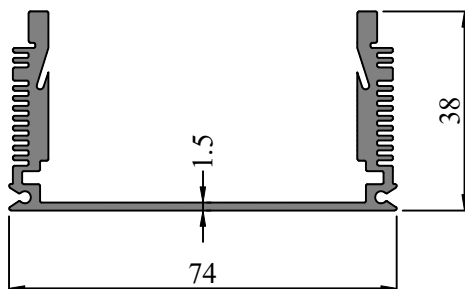

SEC. NO. IS0039
WEIGHT - 0.540 Kg/M

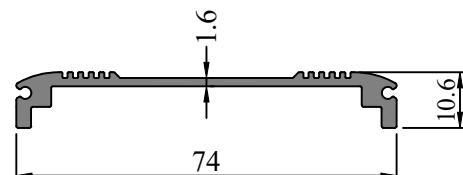

ALL DIMENSIONS ARE IN MM

WEIGHT TOLERANCE ± 7 TO 10%

REVISED ON DATE - 24/03/2026

SATYA METAL INDUSTRIES PVT.LTD

Address : Khasra No.480, Shimla Pistaar, Kichha Road Rudrapur, U.s.Nagar, Uttarakhand - 263153
 Mob: +91-8477897789 | +91-9415215083 | E-mail : satyametal@rediffmail.com | Website : www.satyametal.com

SEC.NO. IS0040
WEIGHT - 0.245 Kg/M

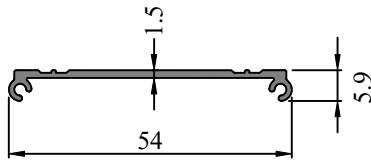

SEC. NO. IS0045
WEIGHT - 3.020 Kg/M

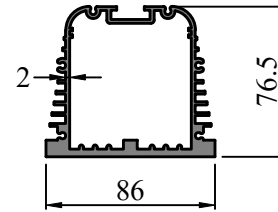

SEC. NO. IS0055
WEIGHT - 0.770 Kg/M

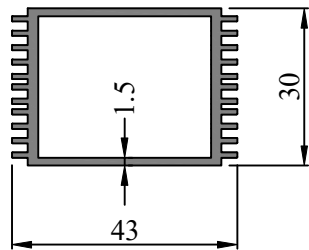

SEC. NO. IS0056
WEIGHT - 1.20 Kg/M

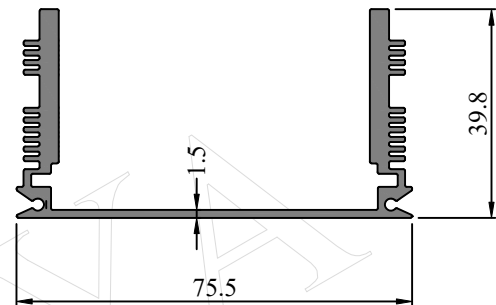

SEC. NO. IS0057
WEIGHT - 0.610 Kg/M

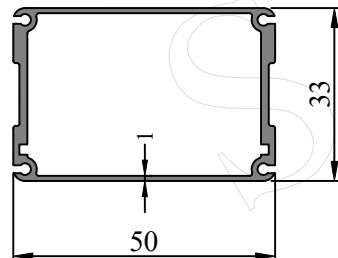

SEC. NO. IS0066
WEIGHT - 0.610 Kg/M

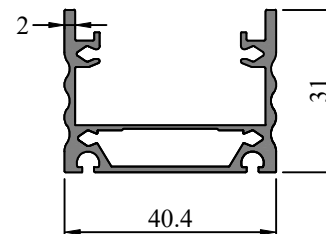

SEC. NO. IS0068
WEIGHT - 0.590 Kg/M

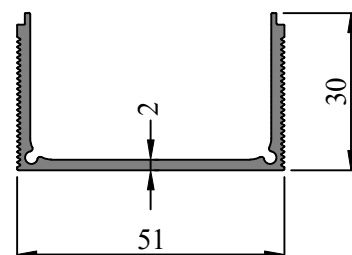

SEC.NO.IS0069
WEIGHT - 0.340 Kg/M

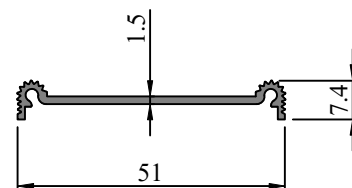

ALL DIMENSIONS ARE IN MM

WEIGHT TOLERANCE ± 7 TO 10%

REVISED ON DATE - 24/03/2026

SATYA METAL INDUSTRIES PVT.LTD

Address : Khasra No.480, Shimla Pistaar, Kichha Road Rudrapur, U.s.Nagar, Uttarakhand - 263153
 Mob: +91-8477897789 | +91-9415215083 | E-mail : satyametal@rediffmail.com | Website : www.satyametal.com

SEC. NO. IS0070R2
WEIGHT - 0.225 Kg/M

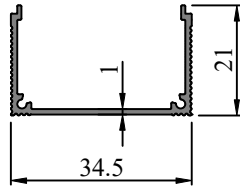

SEC. NO. IS0071R2
WEIGHT - 0.138 Kg/M

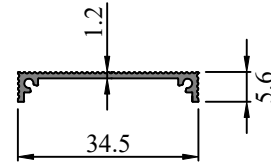

SEC. NO. IS0088
WEIGHT - 0.600 Kg/M

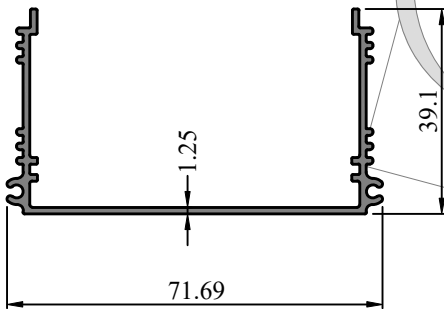

SEC. NO. IS0089
WEIGHT - 0.345 Kg/M

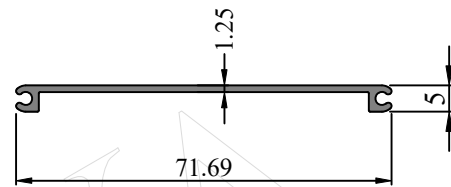

SEC.NO. IS0095
WEIGHT - 0.430 Kg/M

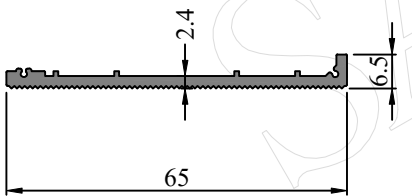

SEC.NO. IS0096
WEIGHT - 0.280 Kg/M

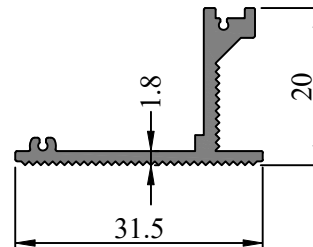

SEC. NO. IS0097
WEIGHT - 0.520 Kg/M

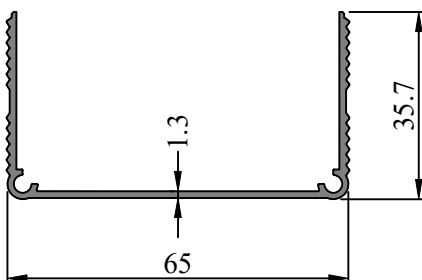

SEC.NO.IS0098
WEIGHT - 0.300 Kg/M

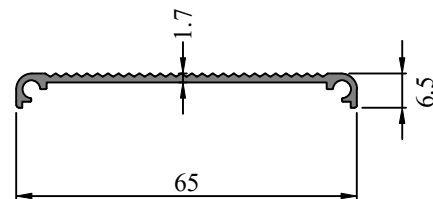

ALL DIMENSIONS ARE IN MM

WEIGHT TOLERANCE ± 7 TO 10%

REVISED ON DATE - 24/03/2026

SATYA METAL INDUSTRIES PVT.LTD

Address : Khasra No.480, Shimla Pistaar, Kichha Road Rudrapur, U.s.Nagar, Uttarakhand - 263153
 Mob: +91-8477897789 | +91-9415215083 | E-mail : satyametal@rediffmail.com | Website : www.satyametal.com

SEC. NO. IS00125
 WEIGHT - 0.760 Kg/M

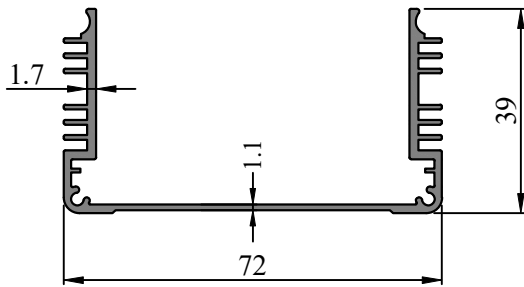

SEC. NO. IS00126
 WEIGHT - 0.330 Kg/M

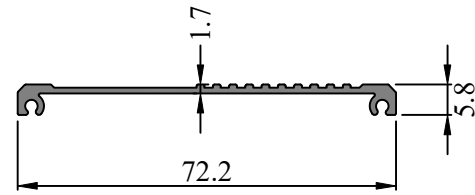

SEC. NO. IS00130R2
 WEIGHT - 1.0 Kg/M

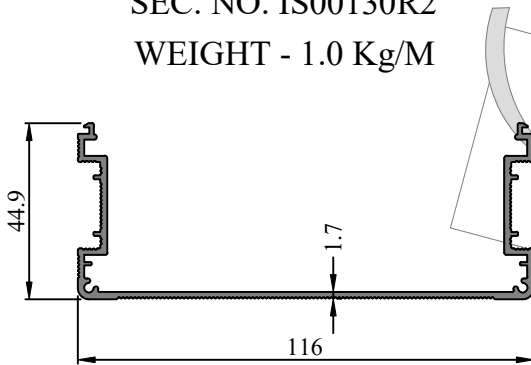

SEC. NO. IS00131R2
 WEIGHT - 0.570 Kg/M

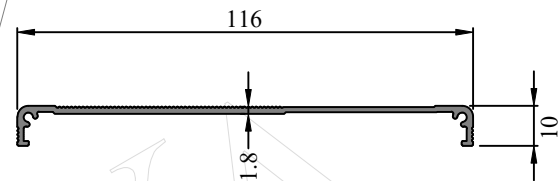

SEC. NO. IS00146
 WEIGHT - 1.00 Kg/M

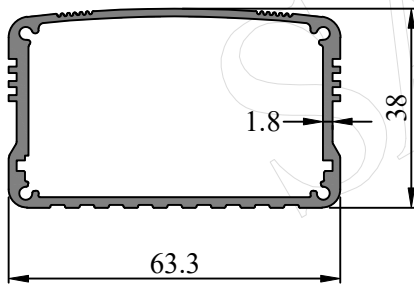

SEC. NO. IS00152
 WEIGHT - 0.330 Kg/M

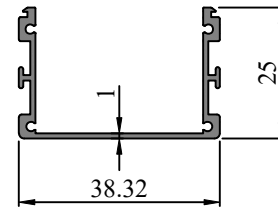

SEC. NO. IS00153
 WEIGHT - 0.110 Kg/M

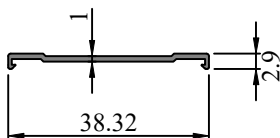

SEC. NO. IS00154R1
 WEIGHT - 0.500 Kg/M

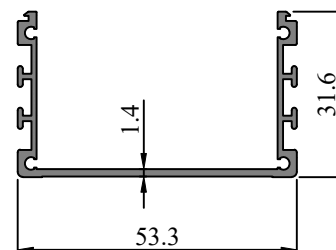

ALL DIMENSIONS ARE IN MM

WEIGHT TOLERANCE ± 7 TO 10%

REVISED ON DATE - 24/03/2026

SATYA METAL INDUSTRIES PVT.LTD

Address : Khasra No.480, Shimla Pistaar, Kichha Road Rudrapur, U.s.Nagar, Uttarakhand - 263153
 Mob: +91-8477897789 | +91-9415215083 | E-mail : satyametal@rediffmail.com | Website : www.satyametal.com

SEC. NO. IS00155R1
WEIGHT - 0.160 Kg/M

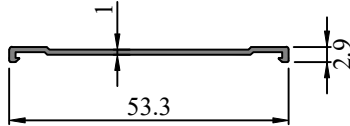

SEC. NO. IS00161
WEIGHT - 0.400 Kg/M

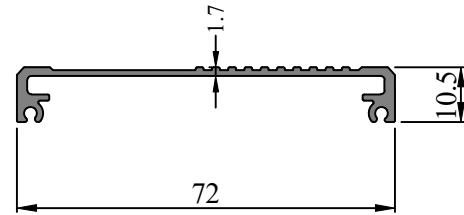

SEC. NO. IS00162
WEIGHT - 0.600 Kg/M

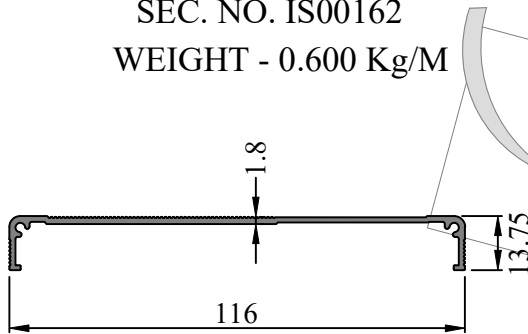

SEC. NO. IS00171
WEIGHT - 0.660 Kg/M

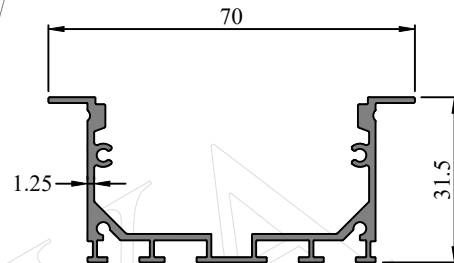

SEC. NO. IS00183
WEIGHT - 0.393 Kg/M

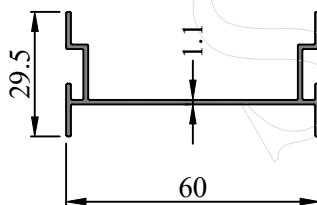

SEC. NO. IS00187
WEIGHT - 0.170 Kg/M

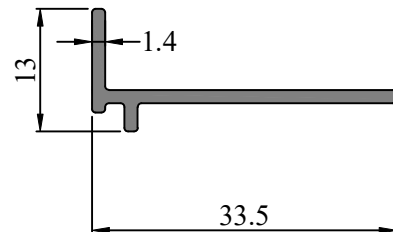

SEC. NO. IS00220
WEIGHT - 0.283 Kg/M

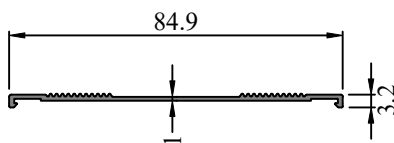

SEC. NO. IS00219
WEIGHT - 0.687 Kg/M

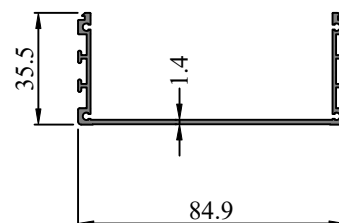

ALL DIMENSIONS ARE IN MM

WEIGHT TOLERANCE ± 7 TO 10%

REVISED ON DATE - 24/03/2026

SATYA METAL INDUSTRIES PVT.LTD

Address : Khasra No.480, Shimla Pistaar, Kichha Road Rudrapur, U.s.Nagar, Uttarakhand - 263153
 Mob: +91-8477897789 | +91-9415215083 | E-mail : satyametal@rediffmail.com | Website : www.satyametal.com

SEC. NO. IS00222
WEIGHT - 0.317 Kg/M

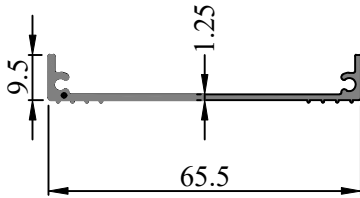

SEC. NO. IS00221
WEIGHT - 0.570 Kg/M

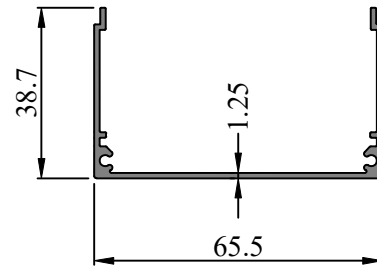

SEC. NO. IS00270
WEIGHT - 0.493 Kg/M

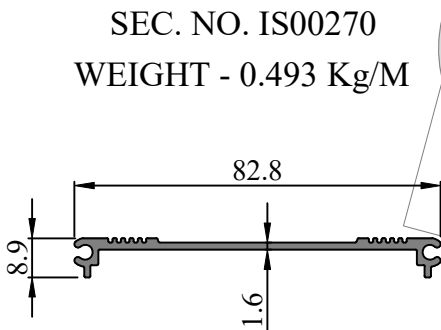

SEC. NO. IS00271
WEIGHT - 1.191 Kg/M

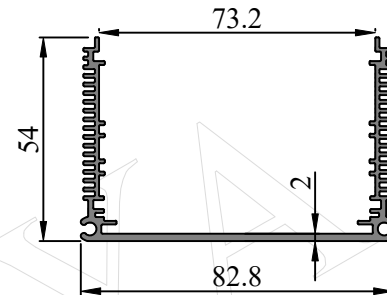

SEC. NO. IS00295
WEIGHT - 1.123 Kg/M

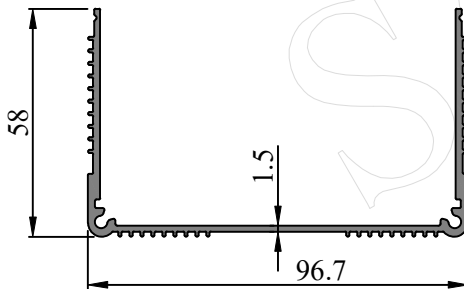

SEC. NO. IS00296
WEIGHT - 0.588 Kg/M

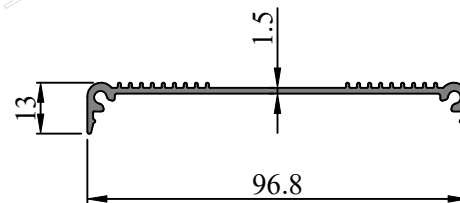

ALL DIMENSIONS ARE IN MM

WEIGHT TOLERANCE ± 7 TO 10%

REVISED ON DATE - 24/03/2026

SATYA METAL INDUSTRIES PVT.LTD

Address : Khasra No.480, Shimla Pistaar, Kichha Road Rudrapur, U.s.Nagar, Uttarakhand - 263153
 Mob: +91-8477897789 | +91-9415215083 | E-mail : satyametal@rediffmail.com | Website : www.satyametal.com